

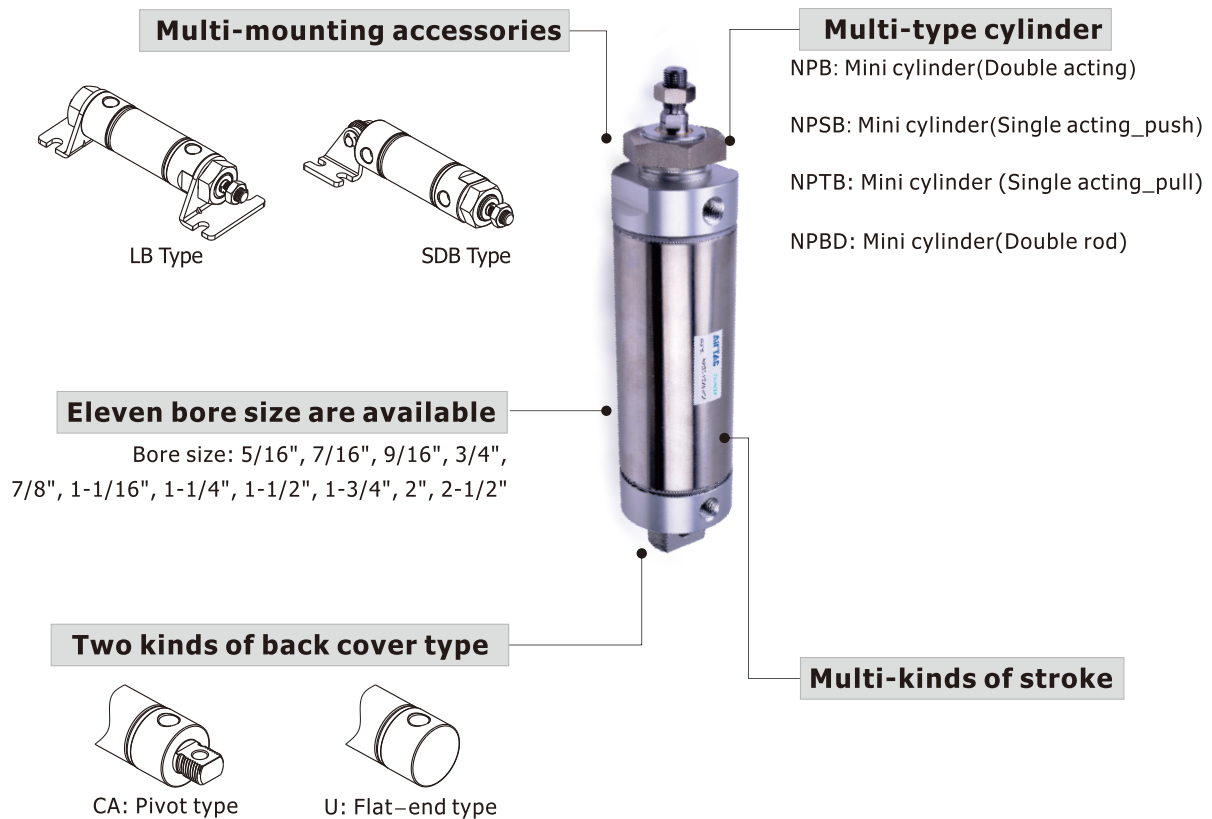

Mini cylinder(Stainless steel)——NPB Series

Compendium of NPB Series



Installation and application



1. When load changes in the work, the cylinder with abundant output capacity shall be selected.
2. Relative cylinder with high temperature resistance or corrosion resistance shall be chosen under the condition of high temperature or corrosion.
3. Necessary protection measure shall be taken in the environment with higher humidity, much dust or water drops, oil dust and welding dregs.
4. Dirty substances in the pipe must be eliminated before cylinder is connected with pipeline to prevent the entrance of particles into the cylinder.
5. The medium used by cylinder shall be filtered to 40μm or below.
6. Anti-freezing measure shall be adopted under low temperature environment to prevent moisture freezing.
7. To avoid side load, otherwise, piston rod will be bent and deformed and damage the thread at the end of the rod.
Single-acting type can not be added in return.
8. If the cylinder is dismantled and stored for a long time, Please to conduct anti-rust treatment to the surface. Anti-dust caps shall be added in air inlet and outlet ports. The front and back cover can not be dismantled, which shall be especially noticed.



Mini cylinder(Stainless steel)

NPB Series

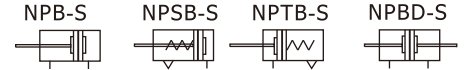

Ordering code

NPB 1-1/2 x 4 S □ □ T

① ② ③ ④ ⑤ ⑥ ⑦

① Model

NPB: Mini cylinder(Double acting)
 NPSB: Mini cylinder(Single acting_push)
 NPTB: Mini cylinder (Single acting_pull)
 NPBD: Mini cylinder(Double rod)

⑦ Thread type

No this code [Note]	5/16" 7/16" 9/16"
T: NPT	Others

[Note] $\Phi 5/16'' \sim \Phi 9/16''$ thread are #10-32 UNF.

② Bore size

5/16"	NPB NPSB NPTB
7/16" 9/16" 3/4" 7/8"	NPB NPBD
1-1/16" 1-1/4" 1-1/2" 1-3/4" 2"	NPSB NPTB
2-1/2"	NPB NPBD

③ Stroke

Refer to stroke table for details

④ Magnet

S: With magnet

⑤ Back cover

CA: Pivot type	NPB/NPSB/NPTB
U: Flat-end type	
CM: Round-end type	NPB1-1/2
No this code	NPBD

⑥ Mounting type

Blank: No accessories	
LB: LB type	NPB/NPSB/NPTB
SDB: SDB typecode	
Blank: No accessories	NPBD
LB: LB type	

Stroke

Bore size(in)	Standard stroke (in)	Max.Std stroke (in)	Max. stroke (in)	
NPB	5/16"	1/2 1 1-1/2 2 2-1/2 3 4 5 6	6	8
	7/16"	1/2 1 1-1/2 2 2-1/2 3 4 5 6 7 8	8	8
	9/16"	1/2 1 1-1/2 2 2-1/2 3 4 5 6 7 8 9 10 11 12	12	12
	3/4" ~ 2-1/2"	1/2 1 1-1/2 2 2-1/2 3 4 5 6 7 8 9 10 11 12 13 14 15 16 17 18 19 20	20	32
NPBD	7/16"	1/2 1 1-1/2 2 2-1/2 3 4	4	-
	9/16"	1/2 1 1-1/2 2 2-1/2 3 4 5 6 7 8	8	-
	3/4" ~ 1-1/16"	1/2 1 1-1/2 2 2-1/2 3 4 5 6 7 8 9 10 11 12	12	-
	1-1/4" ~ 2-1/2"	1/2 1 1-1/2 2 2-1/2 3 4 5 6 7 8 9 10 11 12 13 14 15 16 17 18 19 20	20	-
NPSB NPTB	5/16"~9/16"	1/2 1 1-1/2 2	-	-
	3/4" ~ 2"	1/2 1 1-1/2 2 2-1/2 3 4	-	-

[Note] Consult us for non-standard stroke.

Product feature

1. It belongs to mini cylinder that has compact structure, small volume and light weight.
2. The guide precision of piston rod is high and no additional lubricant is needed.
3. Piston rod stainless steel barrel make the cylinder adapt general corrosive working environment.
4. There are cylinders and accessories with several specifications for installation for your choice.
5. It has small cylinder diameter and quick reaction, suitable for the working environment with higher frequency.

Mini cylinder(Stainless steel)

NPB Series

Specification

Bore size(in)		5/16	7/16	9/16	3/4	7/8	1-1/16	1-1/4	1-1/2	1-3/4	2	2-1/2
Acting type	NPSB/NPTB	Single acting										-
	NPB	Double acting										
	NPBD	-	Double acting									
Fluid		Air(to be filtered by 40μm filter element)										
Operating pressure	Double acting	22~145psi(0.15~1.0MPa)										
	Single acting	28~145psi(0.2~1.0MPa)										
Proof pressure		215psi(1.5MPa)										
Temperature		-5°F~160°F(-20°C~70°C)										
Speed range inch/s		2~32										
Stroke tolerance inch		0~6 ^{+0.04} ₀ >6 ^{+0.06} ₀										
Cushion type		Bumper										
Port size		#10-32UNF					NPT1/8				NPT1/4	

Inner structure

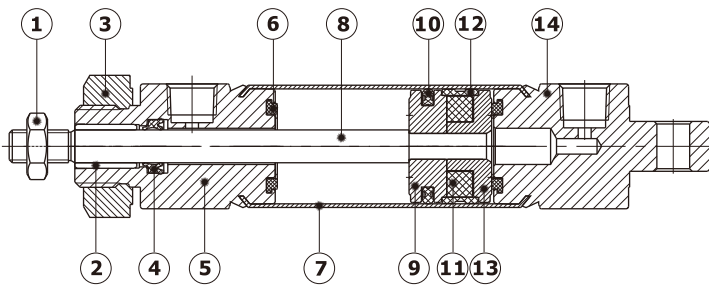

NO.	Item	NO.	Item
1	Rod nut	8	Piston rod
2	Bushing	9	Piston
3	Front cover nut	10	Piston seal
4	Front cover O-ring	11	Magnet
5	Front cover	12	Wear ring
6	Bumper	13	Magnet holder
7	Barrel	14	Back cover

Dimensions

NPB $\Phi 5/16"$ $\Phi 7/16"$

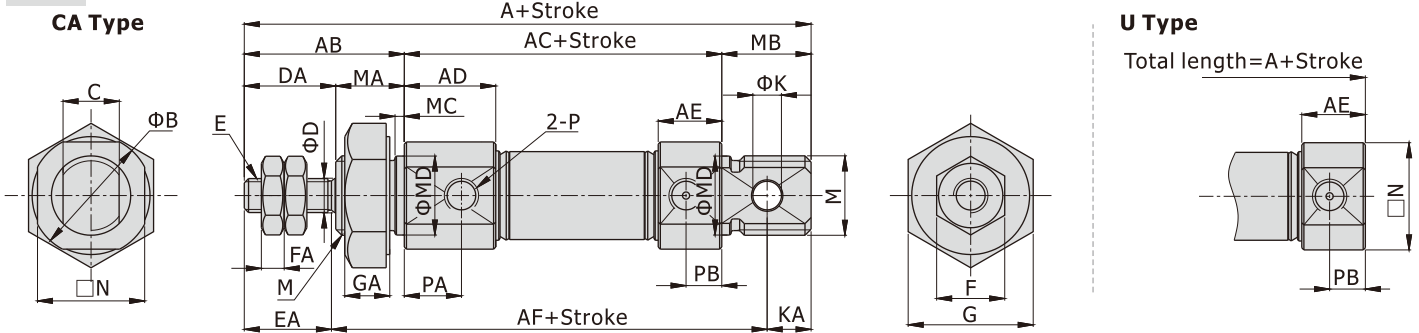

Bore size\Item	A		AB	AC	AD	AE	AF	B	C	D	DA	E	EA	F	FA	G	GA	H
	CA	U																
5/16"	2.57	2.22	0.69	1.53	0.38	0.31	2.03	0.58	1/4	1/8	0.38	#5-40UNC	0.38	1/4	0.11	9/16	0.22	-
7/16"	3.31	2.81	0.88	1.93	0.48	0.39	2.55	0.67	5/16	3/16	0.50	#10-32UNF	0.50	3/8	0.13	11/16	0.25	-

Bore size\Item	K	KA	M	MA	MB	MC	MD	N	P	PA	PB
5/16"	1/8	0.16	3/8-24UNF	0.31	0.35	-	-	1/2	#10-32UNF	0.24	0.16
7/16"	5/32	0.25	7/16-20UNF	0.38	0.50	0.05	0.437 ^{0.004}	3/5	#10-32UNF	0.28	0.20

Mini cylinder(Stainless steel)

NPB Series

NPB $\Phi 9/16'' \sim \Phi 1-1/4''$ $\Phi 1-3/4'' \sim \Phi 2-1/2''$

CA Type

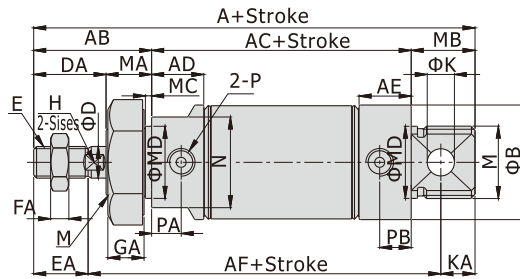
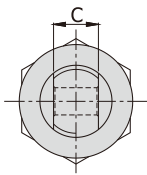

U Type

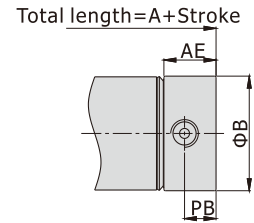

[Unit:inch]

Bore size\Item	A		AB	AC	AD	AE	AF	B	C	D	DA	E	EA	F	FA	G	GA	H
	CA	U																
9/16"	3.25	2.81	0.88	1.93	0.47	0.38	2.55	0.67	5/16	3/16	0.50	#10-32UNF	0.50	3/8	0.13	11/16	0.25	-
3/4"	4.53	3.91	1.00	2.91	0.69	0.69	3.75	0.86	3/8	1/4	0.50	1/4-28UNF	0.50	7/16	0.16	15/16	0.37	-
7/8"	4.34	3.72	1.00	2.72	0.66	0.66	3.56	0.95	3/8	1/4	0.50	1/4-28UNF	0.50	7/16	0.16	15/16	0.37	-
1-1/16"	4.62	4.00	1.12	2.88	0.70	0.70	3.85	1.14	3/8	5/16	0.62	5/16-24UNF	0.50	1/2	0.19	15/16	0.37	1/4
1-1/4"	5.88	5.06	1.63	3.43	0.77	0.77	4.73	1.34	1/2	7/16	1.00	7/16-20UNF	0.75	11/16	0.25	1-1/8	0.42	3/8
1-3/4"	7.13	6.13	1.94	4.19	1.02	1.02	5.74	1.83	5/8	1/2	1.19	1/2-20UNF	0.88	3/4	0.31	1-1/2	0.50	7/16
2"	6.94	5.94	2.07	3.87	0.96	0.96	5.61	2.10	3/4	5/8	1.26	1/2-20UNF	0.88	3/4	0.31	1-7/8	0.50	1/2
2-1/2"	6.94	5.94	2.07	3.87	0.96	0.96	5.61	2.60	3/4	5/8	1.26	1/2-20UNF	0.88	3/4	0.31	2-1/16	0.50	1/2

Bore size\Item	K	KA	M	MA	MB	MC	MD	N	P	PA	PB
9/16"	5/32	0.19	7/16-20UNF	0.38	0.44	0.06	0.437 ⁰ _{-0.004}	9/16	#10-32UNF	0.28	0.20
3/4"	1/4	0.28	5/8-18UNF	0.50	0.62	0.09	0.624 ⁰ _{-0.004}	3/4	NPT1/8	0.37	0.37
7/8"	1/4	0.28	5/8-18UNF	0.50	0.62	0.09	0.624 ⁰ _{-0.004}	13/16	NPT1/8	0.37	0.37
1-1/16"	1/4	0.28	5/8-18UNF	0.50	0.62	0.09	0.624 ⁰ _{-0.004}	1	NPT1/8	0.39	0.39
1-1/4"	1/4	0.41	3/4-16UNF	0.63	0.82	0.09	0.750 ⁰ _{-0.004}	1-1/8	NPT1/8	0.43	0.43
1-3/4"	3/8	0.50	1-14UNS	0.75	1.00	0.09	1.032 ⁰ _{-0.004}	1-5/8	NPT1/4	0.51	0.51
2"	3/8	0.44	1-1/4-12UNF	0.81	1.00	0.12	1.375 ⁰ _{-0.004}	1-7/8	NPT1/4	0.51	0.51
2-1/2"	3/8	0.44	1-3/8-12UNF	0.81	1.00	0.12	1.500 ⁰ _{-0.004}	2-3/8	NPT1/4	0.51	0.51

NPB $\Phi 1-1/2''$

CA Type

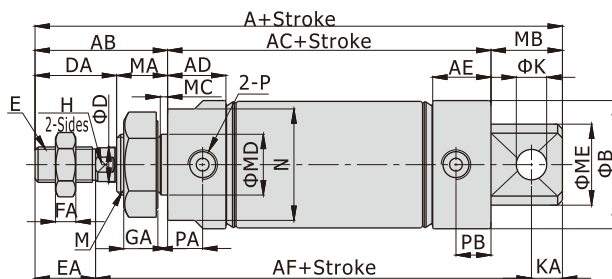
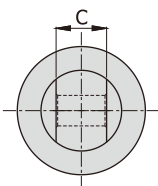

U Type

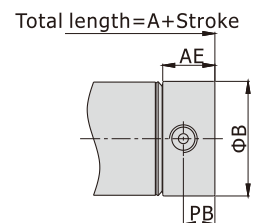

[Unit:inch]

Bore size\Item	A			AB	AC	AD	AE	AF	B	C	D	DA	E	EA
	CM	CA	U											
1-1/2"	5.26	5.51	4.63	1.63	3.00	0.72	0.72	4.39	1.58	5/8	7/16	1.00	7/16-20UNF	0.75
Bore size\Item	F	FA	G	GA	H	K	KA	M	MA					
1-1/2"	11/16	0.25	1-1/8	0.42	3/8	3/8	0.38	3/4-16UNF	0.63					
Bore size\Item	MB		MC	MD	ME		N	P	PA	PB				
Back cover type	CM	CA			CM	CA								
1-1/2"	0.63	0.88	0.09	0.75 ⁰ _{-0.004}	0.75 ⁰ _{-0.004}	1.00 ⁰ _{-0.004}	1-3/8	NPT1/8	0.43	0.43				

CM Type

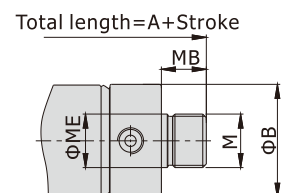

Mini cylinder(Stainless steel)

NPB Series

NPBD $\Phi 7/16"$

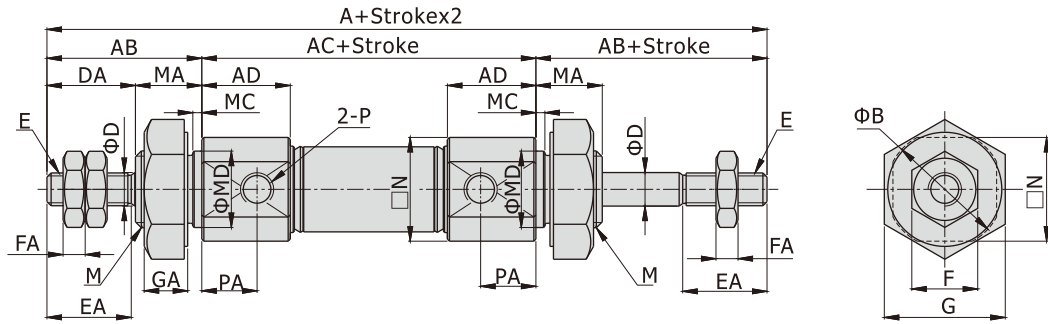

NPBD $\Phi 9/16" \sim \Phi 2-1/2"$

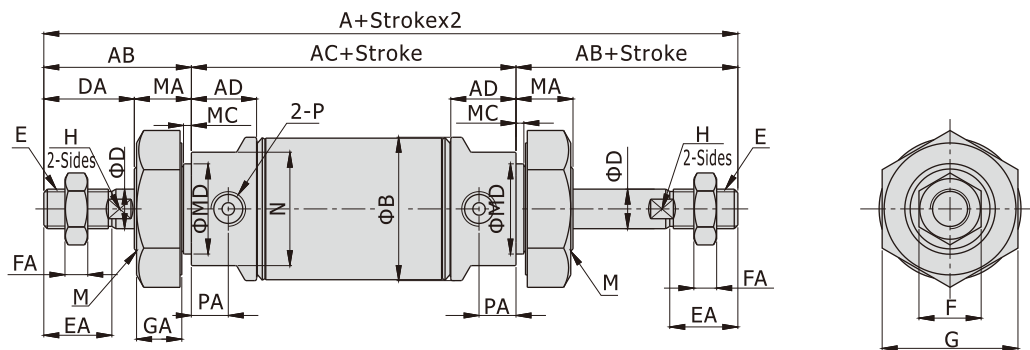

[Unit:inch]

Bore size\Item	A	AB	AC	AD	B	D	DA	E	EA	F	FA	G	GA	H
7/16"	3.75	0.88	2.00	0.48	0.67	3/16	0.50	#10-32UNF	0.50	3/8	0.13	11/16	0.25	-
9/16"	3.78	0.88	2.02	0.47	0.67	3/16	0.50	#10-32UNF	0.50	3/8	0.13	11/16	0.25	-
3/4"	4.91	1.00	2.91	0.69	0.86	1/4	0.50	1/4-28UNF	0.50	7/16	0.16	15/16	0.37	-
7/8"	4.72	1.00	2.72	0.66	0.95	1/4	0.50	1/4-28UNF	0.50	7/16	0.16	15/16	0.37	-
1-1/16"	5.12	1.12	2.88	0.70	1.14	5/16	0.62	5/16-24UNF	0.50	1/2	0.19	15/16	0.37	1/4
1-1/4"	6.69	1.63	3.43	0.77	1.34	7/16	1.00	7/16-20UNF	0.75	11/16	0.25	1-1/8	0.42	3/8
1-1/2"	6.26	1.63	3.00	0.72	1.58	7/16	1.00	7/16-20UNF	0.75	11/16	0.25	1-1/8	0.42	3/8
1-3/4"	8.07	1.94	4.19	1.02	1.83	1/2	1.19	1/2-20UNF	0.88	3/4	0.31	1-1/2	0.50	7/16
2"	8.02	2.07	3.87	0.96	2.10	5/8	1.26	1/2-20UNF	0.88	3/4	0.31	1-7/8	0.50	1/2
2-1/2"	8.02	2.07	3.87	0.96	2.60	5/8	1.26	1/2-20UNF	0.88	3/4	0.31	2-1/16	0.50	1/2

Bore size\Item	M	MA	MC	MD	N	P	PA
7/16"	7/16-20UNF	0.38	0.05	0.437 ⁰ _{-0.004}	3/5	#10-32UNF	0.28
9/16"	7/16-20UNF	0.38	0.06	0.437 ⁰ _{-0.004}	9/16	#10-32UNF	0.28
3/4"	5/8-18UNF	0.50	0.09	0.624 ⁰ _{-0.004}	3/4	NPT1/8	0.37
7/8"	5/8-18UNF	0.50	0.09	0.624 ⁰ _{-0.004}	13/16	NPT1/8	0.37
1-1/16"	5/8-18UNF	0.50	0.09	0.624 ⁰ _{-0.004}	1	NPT1/8	0.39
1-1/4"	3/4-16UNF	0.63	0.09	0.750 ⁰ _{-0.004}	1-1/8	NPT1/8	0.43
1-1/2"	3/4-16UNF	0.63	0.09	0.750 ⁰ _{-0.004}	1-3/8	NPT1/8	0.43
1-3/4"	1-14UNS	0.75	0.09	1.032 ⁰ _{-0.004}	1-5/8	NPT1/4	0.51
2"	1-1/4-12UNF	0.81	0.12	1.375 ⁰ _{-0.004}	1-7/8	NPT1/4	0.51
2-1/2"	1-3/8-12UNF	0.81	0.12	1.500 ⁰ _{-0.004}	2-3/8	NPT1/4	0.51

Mini cylinder(Stainless steel)

NPB Series

NPSB $\Phi 5/16''$ $\Phi 7/16''$

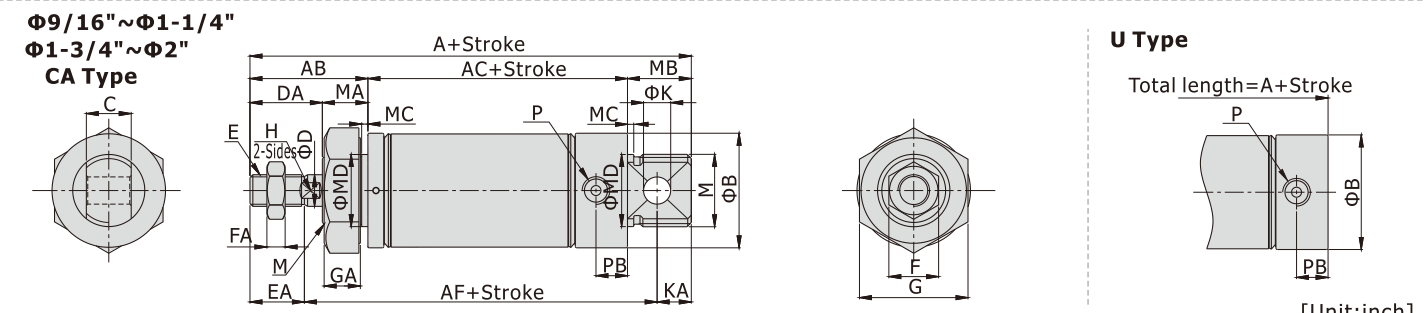
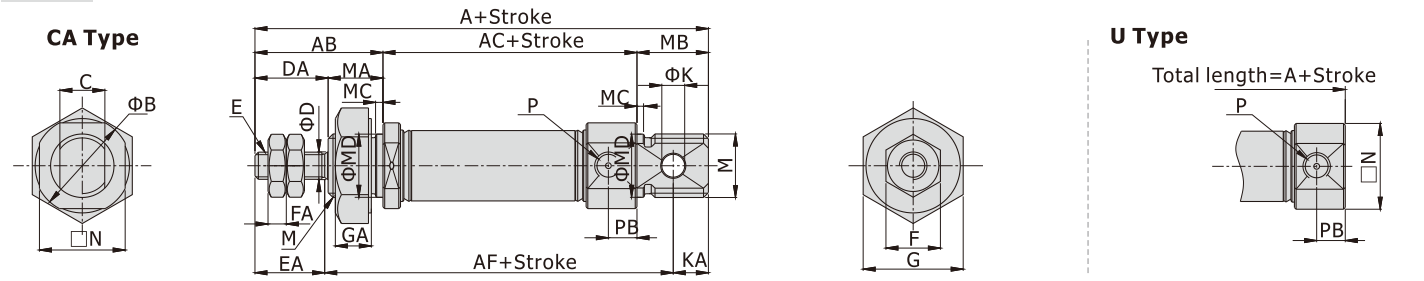

[Unit:inch]

Bore size \ Item Back cover type	A								AB	AC				AF				B	C	D	DA
	CA				U					-				-							
Stroke	1/2,1	1-1/2,2	2-1/2,3	4	1/2,1	1-1/2,2	2-1/2,3	4	-	1/2,1	1-1/2,2	2-1/2,3	4	1/2,1	1-1/2,2	2-1/2,3	4	-	-	-	-
5/16"	3.07	3.32	-	-	2.72	2.97	-	-	0.69	2.03	2.28	-	-	2.53	2.78	-	-	0.58	1/4	1/8	0.38
7/16"	3.81	4.06	-	-	3.31	3.56	-	-	0.88	2.43	2.68	-	-	3.06	3.31	-	-	0.67	5/16	3/16	0.50
9/16"	3.75	4.00	-	-	3.31	3.56	-	-	0.88	2.43	2.68	-	-	3.06	3.31	-	-	0.67	5/16	3/16	0.50
3/4"	4.66	4.91	5.53	5.78	4.04	4.29	4.91	5.16	1.00	3.04	3.29	3.91	4.16	3.88	4.13	4.75	5.00	0.86	3/8	1/4	0.50
7/8"	4.47	4.72	5.34	5.59	3.85	4.10	4.72	4.97	1.00	2.85	3.10	3.72	3.97	3.69	3.94	4.56	4.81	0.95	3/8	1/4	0.50
1-1/16"	4.75	5.00	5.62	5.87	4.13	4.38	5.00	5.25	1.12	3.01	3.26	3.88	4.13	3.97	4.22	4.84	5.09	1.14	3/8	5/16	0.62
1-1/4"	6.00	6.25	6.88	7.13	5.19	5.44	6.06	6.31	1.63	3.56	3.81	4.43	4.68	4.85	5.10	5.72	5.97	1.34	1/2	7/16	1.00
1-3/4"	7.26	7.51	8.13	8.38	6.26	6.51	7.13	7.38	1.94	4.32	4.57	5.19	5.44	5.88	6.13	6.75	7.00	1.83	5/8	1/2	1.19
2"	7.07	7.32	7.94	8.19	6.07	6.32	6.94	7.19	2.07	4.00	4.25	4.87	5.12	5.75	6.00	6.62	6.87	2.10	3/4	5/8	1.26
Bore size \ Item	E	EA	F	FA	G	GA	H	K	KA	M	MA	MB	MC	MD	N	P	PB				
5/16"	#5-40UNC	0.38	1/4	0.11	9/16	0.22	-	1/8	0.16	3/8-24UNF	0.31	0.35	-	-	1/2	#10-32UNF	0.16				
7/16"	#10-32UNF	0.50	3/8	0.13	11/16	0.25	-	5/32	0.25	7/16-20UNF	0.38	0.50	0.05	0.437 ⁰ _{-0.004}	3/5	#10-32UNF	0.20				
9/16"	#10-32UNF	0.50	3/8	0.13	11/16	0.25	-	5/32	0.19	7/16-20UNF	0.38	0.44	0.06	0.437 ⁰ _{-0.004}	-	#10-32UNF	0.20				
3/4"	1/4-28UNF	0.50	7/16	0.16	15/16	0.37	-	1/4	0.28	5/8-18UNF	0.50	0.62	0.09	0.624 ⁰ _{-0.004}	-	NPT1/8	0.37				
7/8"	1/4-28UNF	0.50	7/16	0.16	15/16	0.37	-	1/4	0.28	5/8-18UNF	0.50	0.62	0.09	0.624 ⁰ _{-0.004}	-	NPT1/8	0.37				
1-1/16"	5/16-24UNF	0.50	1/2	0.19	15/16	0.37	1/4	1/4	0.28	5/8-18UNF	0.50	0.62	0.09	0.624 ⁰ _{-0.004}	-	NPT1/8	0.39				
1-1/4"	7/16-20UNF	0.75	11/16	0.25	1-1/8	0.42	3/8	1/4	0.41	3/4-16UNF	0.63	0.82	0.09	0.750 ⁰ _{-0.004}	-	NPT1/8	0.43				
1-3/4"	1/2-20UNF	0.88	3/4	0.31	1-1/2	0.50	7/16	3/8	0.50	1-14UNS	0.75	1.00	0.09	1.032 ⁰ _{-0.004}	-	NPT1/4	0.51				
2"	1/2-20UNF	0.88	3/4	0.31	1-7/8	0.50	1/2	3/8	0.44	1-1/4-12UNF	0.81	1.00	0.12	1.375 ⁰ _{-0.004}	-	NPT1/4	0.51				

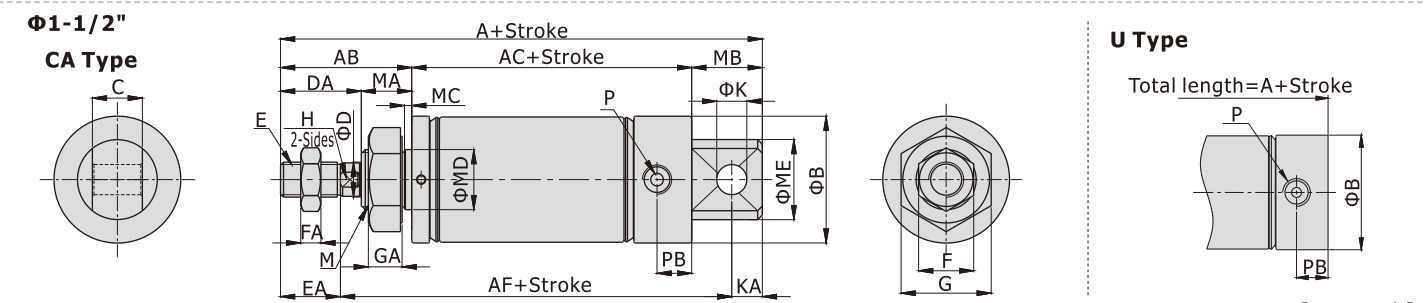

[Unit:inch]

Bore size \ Item Back cover type	A								AB	AC				AF				B	C	D	DA
	CA				U					-				-							
Stroke	1/2,1	1-1/2,2	2-1/2,3	4	1/2,1	1-1/2,2	2-1/2,3	4	-	1/2,1	1-1/2,2	2-1/2,3	4	1/2,1	1-1/2,2	2-1/2,3	4	-	-	-	-
1-1/2"	5.64	5.89	6.51	6.76	4.76	5.01	5.63	5.88	1.63	3.13	3.38	4.00	4.25	4.51	4.76	5.38	5.63	1.58	5/8	7/16	1.00
Bore size \ Item	E	EA	F	FA	G	GA	H	K	KA	M	MA	MB	MC	MD	ME	P	PB				
1-1/2"	7/16-20UNF	0.75	11/16	0.25	1-1/8	0.42	3/8	3/8	0.38	3/4-16UNF	0.63	0.88	0.09	0.75 ⁰ _{-0.004}	1.00 ⁰ _{-0.004}	NPT1/8	0.43				

Mini cylinder(Stainless steel)

NPB Series

NPTB $\Phi 5/16"$ $\Phi 7/16"$

CA Type

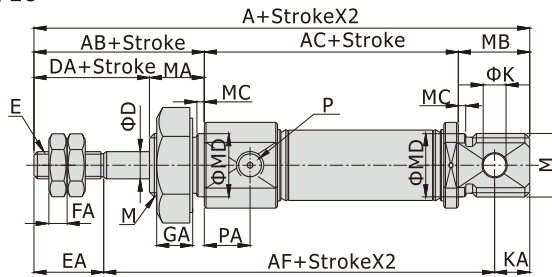
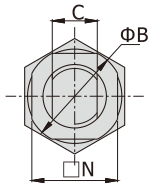

U Type

Total length=A+StrokeX2

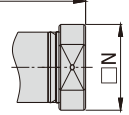

$\Phi 9/16"$ ~ $\Phi 1-1/4"$
 $\Phi 1-3/4"$ ~ $\Phi 2"$

CA Type

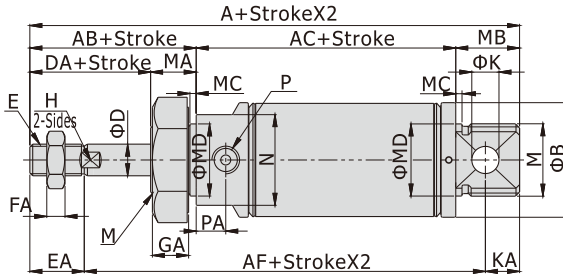
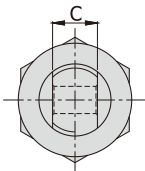

U Type

Total length=A+StrokeX2

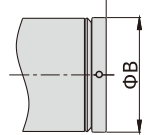

[Unit:inch]

Bore size \ Item	A				AB	AC				AF				B	C	D	DA				
	CA		U			-				-											
Stroke	1/2,1	1-1/2,2	2-1/2,3	4	1/2,1	1-1/2,2	2-1/2,3	4	-	1/2,1	1-1/2,2	2-1/2,3	4	1/2,1	1-1/2,2	2-1/2,3	4	-	-	-	-
5/16"	3.07	3.32	-	-	2.72	2.97	-	-	0.69	2.03	2.28	-	-	2.53	2.78	-	-	0.58	1/4	1/8	0.38
7/16"	3.81	4.06	-	-	3.31	3.56	-	-	0.88	2.43	2.68	-	-	3.06	3.31	-	-	0.67	5/16	3/16	0.50
9/16"	3.75	4.00	-	-	3.31	3.56	-	-	0.88	2.43	2.68	-	-	3.06	3.31	-	-	0.67	5/16	3/16	0.50
3/4"	4.66	4.91	5.53	5.78	4.04	4.29	4.91	5.16	1.00	3.04	3.29	3.91	4.16	3.88	4.13	4.75	5.00	0.86	3/8	1/4	0.50
7/8"	4.47	4.72	5.34	5.59	3.85	4.10	4.72	4.97	1.00	2.85	3.10	3.72	3.97	3.69	3.94	4.56	4.81	0.95	3/8	1/4	0.50
1-1/16"	4.75	5.00	5.62	5.87	4.13	4.38	5.00	5.25	1.12	3.01	3.26	3.88	4.13	3.97	4.22	4.84	5.09	1.14	3/8	5/16	0.62
1-1/4"	6.00	6.25	6.88	7.13	5.19	5.44	6.06	6.31	1.63	3.56	3.81	4.43	4.68	4.85	5.10	5.72	5.97	1.34	1/2	7/16	1.00
1-3/4"	7.26	7.51	8.13	8.38	6.26	6.51	7.13	7.38	1.94	4.32	4.57	5.19	5.44	5.88	6.13	6.75	7.00	1.83	5/8	1/2	1.19
2"	7.07	7.32	7.94	8.19	6.07	6.32	6.94	7.19	2.07	4.00	4.25	4.87	5.12	5.75	6.00	6.62	6.87	2.10	3/4	5/8	1.26

Bore size \ Item	E	EA	F	FA	G	GA	H	K	KA	M	MA	MB	MC	MD	N	P	PA
7/16"	#10-32UNF	0.50	3/8	0.13	11/16	0.25	-	5/32	0.25	7/16-20UNF	0.38	0.50	0.05	0.437 ⁰ _{-0.004}	3/5	#10-32UNF	0.28
9/16"	#10-32UNF	0.50	3/8	0.13	11/16	0.25	-	5/32	0.19	7/16-20UNF	0.38	0.44	0.06	0.437 ⁰ _{-0.004}	9/16	#10-32UNF	0.28
3/4"	1/4-28UNF	0.50	7/16	0.16	15/16	0.37	-	1/4	0.28	5/8-18UNF	0.50	0.62	0.09	0.624 ⁰ _{-0.004}	3/4	NPT1/8	0.37
7/8"	1/4-28UNF	0.50	7/16	0.16	15/16	0.37	-	1/4	0.28	5/8-18UNF	0.50	0.62	0.09	0.624 ⁰ _{-0.004}	13/16	NPT1/8	0.37
1-1/16"	5/16-24UNF	0.50	1/2	0.19	15/16	0.37	1/4	1/4	0.28	5/8-18UNF	0.50	0.62	0.09	0.624 ⁰ _{-0.004}	1	NPT1/8	0.39
1-1/4"	7/16-20UNF	0.75	11/16	0.25	1-1/8	0.42	3/8	1/4	0.41	3/4-16UNF	0.63	0.82	0.09	0.750 ⁰ _{-0.004}	1-1/8	NPT1/8	0.43
1-3/4"	1/2-20UNF	0.88	3/4	0.31	1-1/2	0.50	7/16	3/8	0.50	1-14UNS	0.75	1.00	0.09	1.032 ⁰ _{-0.004}	1-5/8	NPT1/4	0.51
2"	1/2-20UNF	0.88	3/4	0.31	1-7/8	0.50	1/2	3/8	0.44	1-1/4-12UNF	0.81	1.00	0.12	1.375 ⁰ _{-0.004}	1-7/8	NPT1/4	0.51

$\Phi 1-1/2"$

CA Type

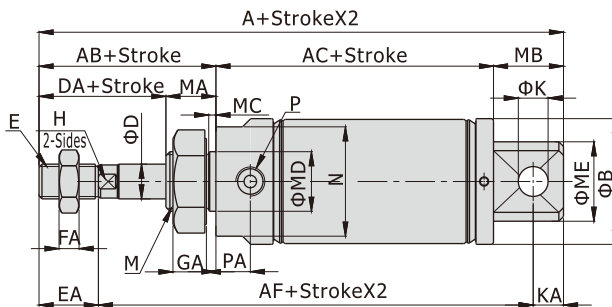
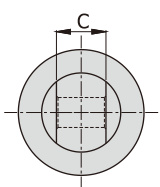

U Type

Total length=A+StrokeX2

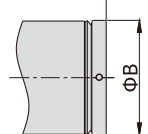

[Unit:inch]

Bore size \ Item	A				AB	AC				AF				B	C	D	DA				
	CA		U			-				-											
Stroke	1/2,1	1-1/2,2	2-1/2,3	4	1/2,1	1-1/2,2	2-1/2,3	4	-	1/2,1	1-1/2,2	2-1/2,3	4	1/2,1	1-1/2,2	2-1/2,3	4	-	-	-	-
1-1/2"	5.64	5.89	6.51	6.76	4.76	5.01	5.63	5.88	1.63	3.13	3.38	4.00	4.25	4.51	4.76	5.38	5.63	1.58	5/8	7/16	1.00

Bore size \ Item	E	EA	F	FA	G	GA	H	K	KA	M	MA	MB	MC	MD	ME	N	P	PA



Mini cylinder(Stainless steel)

NPB Series—Accessories

List for ordering code of accessories

Accessories Bore size	Mounting accessories		Knuckle	Sensor switch	
	LB	SDB	Y	CMSG	DMSG(S)
5/16"	F-NPB5/16LB	F-NPB5/16SDB	F-NPB5/16Y	CMSG	DMSG(S)
7/16"	F-NPB7/16LB	F-NPB7/16SDB	F-NPB7/16Y		
9/16"					
3/4"	F-NPB3/4LB	F-NPB3/4SDB	F-NPB3/4Y		
7/8"			F-NPB1-1/16Y		
1-1/16"					
1-1/4"	F-NPB1-1/4LB	F-NPB1-1/4SDB	F-NPB1-1/4Y		
1-1/2"		F-NPB1-1/2SDB			
1-3/4"	F-NPB1-3/4LB	F-NPB1-3/4SDB	F-NPB1-3/4Y		
2"	F-NPB2LB	F-NPB2SDB			
2-1/2"	F-NPB2-1/2LB				

Accessory selection

Accessories Cylinder model	Mounting accessories		Knuckle	Sensor switch	
	LB	SDB	Y	CMSG	DMSG(S)
NPB	●	●	●	●	●
NPSB/NPTB	●	●	●	●	●
NPBD	●	×	●	●	●

Material of accessories

Accessories Bore size	Mounting accessories		Knuckle
	LB	SDB	Y
5/16"~2-1/2"	<input type="checkbox"/>	<input type="checkbox"/>	<input type="checkbox"/>
<input type="checkbox"/> —Steel			

Dimensions

LB

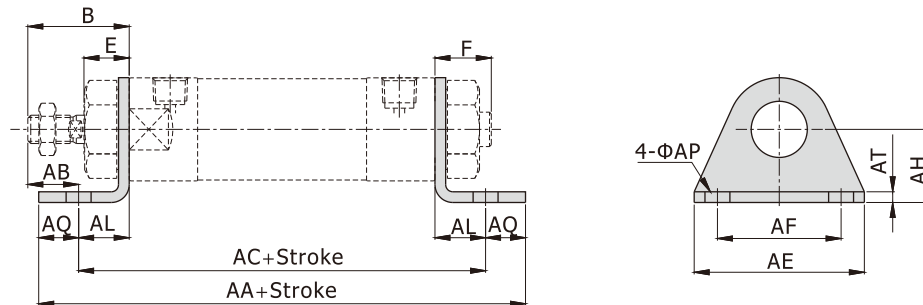

[Unit:inch]

Bore size\Item	AA	AA(NPSB)				AC	AC(NPSB)				B	E	F	AB	AE	AF	AL	AQ	AP	AT	AH
		(NPB)	1/2,1	1-1/2,2	2-1/2,3		4	(NPB)	1/2,1	1-1/2,2											
5/16"	2.29	2.79	3.04	-	-	2.03	2.53	2.78	-	-	0.69	0.31	0.35	0.44	1.00	0.75	0.25	0.13	0.14	0.08	0.44
7/16"	3.30	3.81	4.06	-	-	2.69	3.19	3.44	-	-	0.88	0.38	0.50	0.50	1.38	1.00	0.38	0.31	0.19	0.10	0.56
9/16"	3.30	3.81	4.06	-	-	2.69	3.19	3.44	-	-	0.88	0.38	0.44	0.50	1.38	1.00	0.38	0.31	0.19	0.10	0.56
3/4"	4.91	5.04	5.29	5.91	6.16	4.03	4.15	4.40	5.03	5.28	1.00	0.50	0.62	0.44	1.89	1.50	0.56	0.44	0.28	0.12	0.81
7/8"	4.72	4.85	5.10	5.72	5.97	3.84	3.96	4.21	4.84	5.09	1.00	0.50	0.62	0.44	1.89	1.50	0.56	0.44	0.28	0.12	0.81
1-1/16"	4.88	5.05	5.26	5.88	6.13	4.00	4.12	4.37	5.00	5.25	1.12	0.50	0.62	0.56	1.89	1.50	0.56	0.44	0.28	0.12	0.81
1-1/4"	6.44	6.56	6.81	7.44	7.69	4.93	5.06	5.31	5.93	6.18	1.63	0.63	0.82	0.88	2.50	1.88	0.75	0.75	0.28	0.14	1.00
1-1/2"	6.00	6.13	6.38	7.00	7.25	4.50	4.63	4.88	5.50	5.75	1.63	0.63	0.63	0.88	2.50	1.88	0.75	0.75	0.28	0.14	1.00
1-3/4"	7.19	7.32	7.57	8.19	8.44	5.94	6.07	6.32	6.95	7.20	1.94	0.75	1.00	1.06	3.00	2.24	0.88	0.62	0.34	0.18	1.25
2"	7.11	7.24	7.49	8.11	8.36	5.87	6.00	6.25	6.87	7.12	2.07	0.81	1.00	1.07	3.13	2.24	1.00	0.62	0.34	0.18	1.50
2-1/2"	7.11	-	-	-	-	5.87	-	-	-	-	2.07	0.81	1.00	1.07	3.75	2.87	1.00	0.62	0.34	0.18	1.75

Mini cylinder(Stainless steel)

NPB Series—Accessories

SDB

Φ5/16"

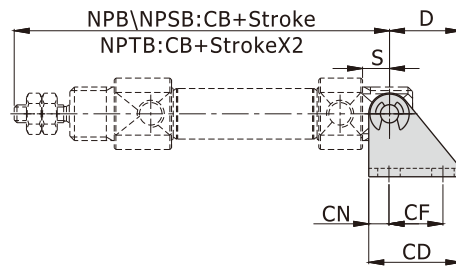
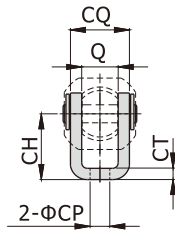

Φ7/16"~Φ2-1/2"

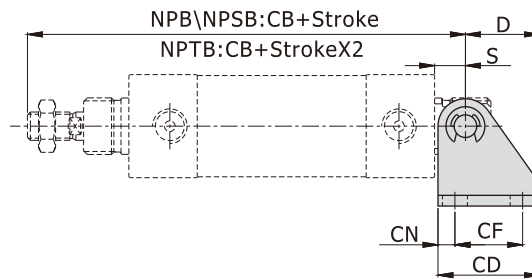
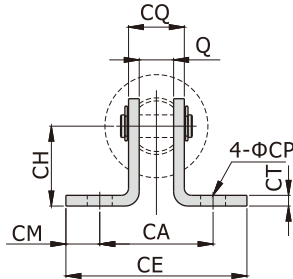

[Unit:inch]

Bore size\Item Stroke	D	S	Q	CA	CB (NPB)	CB(NPSB\NPTB)				CD	CE	CF	CH	CM	CN	CT	CP	CQ
						1/2,1	1-1/2,2	2-1/2,3	4									
5/16"	0.50	0.19	1/4	-	2.41	2.91	3.16	-	-	0.63	-	0.38	0.44	-	0.13	0.08	0.14	0.42
7/16"	0.56	0.25	5/16	0.88	3.05	3.55	3.80	-	-	0.75	1.31	0.50	0.56	0.22	0.13	0.08	0.19	0.47
9/16"	0.56	0.25	5/16	0.88	3.05	3.55	3.80	-	-	0.75	1.31	0.50	0.56	0.22	0.13	0.08	0.19	0.47
3/4"	0.81	0.34	3/8	1.26	4.25	4.38	4.63	5.25	5.50	1.12	2.01	0.75	0.88	0.37	0.19	0.12	0.28	0.63
7/8"	0.81	0.34	3/8	1.26	4.06	4.19	4.44	5.06	5.31	1.12	2.01	0.75	0.88	0.37	0.19	0.12	0.28	0.63
1-1/16"	0.81	0.34	3/8	1.26	4.35	4.48	4.73	5.35	5.60	1.12	2.01	0.75	0.88	0.37	0.19	0.12	0.28	0.63
1-1/4"	0.81	0.41	1/2	1.39	5.48	5.60	5.85	6.48	6.73	1.12	2.13	0.75	0.88	0.37	0.19	0.12	0.28	0.74
1-1/2"	1.13	0.50	5/8	1.75	5.14	5.26	5.51	6.13	6.38	1.50	2.63	1.00	1.38	0.44	0.25	0.12	0.28	0.87
1-3/4"	1.13	0.50	5/8	2.00	6.62	6.75	7.00	7.62	7.87	1.50	2.88	1.00	1.38	0.44	0.25	0.16	0.28	0.95
2"	1.13	0.56	3/4	2.14	6.49	6.62	6.87	7.49	7.74	1.50	3.01	1.00	1.38	0.44	0.25	0.16	0.28	1.08
2-1/2"	1.13	0.56	3/4	2.14	6.49	-	-	-	-	1.50	3.01	1.00	1.38	0.44	0.25	0.16	0.28	1.08

Y Knuckle

[Unit:inch]

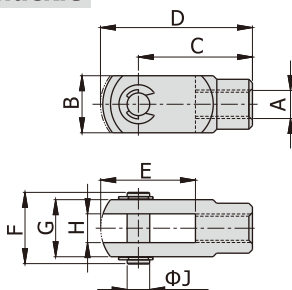

Bore size\Item	A	B	C	D	E	F	G	H	J
F-NPB5/16Y	#5-40UNC	0.32	0.44	0.56	0.38	0.50	0.32	1/8	1/8
F-NPB7/16Y	#10-32UNF	0.38	0.75	0.94	0.56	0.56	0.38	3/16	3/16
F-NPB3/4Y	1/4-28UNF	0.50	0.94	1.19	0.69	0.69	0.50	1/4	1/4
F-NPB1-1/16Y	5/16-24UNF	0.50	0.94	1.19	0.69	0.69	0.50	1/4	1/4
F-NPB1-1/4Y	7/16-20UNF	0.75	1.31	1.69	0.94	1.02	0.75	3/8	3/8
F-NPB1-3/4Y	1/2-20UNF	0.75	1.31	1.69	0.94	1.02	0.75	3/8	3/8